

## Test units and accessories

FDUL221, FDUD29x, FDUD29x-E, RE6, REF8, REF8-S, REF8-C, RE8, RE8-S, RE8-C, RE7T, RE8ST, RE8STCO, RE8-CO, RE7T-x, RE10, FDUM29x, FDLU291, LE3, StabexHF



### Test units to test detectors and detector lines for fire detection installations FS20

- Detector exchanger FDUD291 for the efficient installation and removal of Sinteso point detectors
- Detector exchanger and tester FDUD292 and intelligent detector tester FDUD293 for commissioning, maintenance, and troubleshooting of point detectors, alarm sounders, and linear smoke detectors
- Bluetooth extension kit FDUD29x-E for wireless communication between the detector exchanger and tester FDUD292 and a mobile terminal
- Line tester FDUL221 for diagnosing detector lines
- Detector tester RE6 for use with environmentally-friendly test gas REF8, REF8-S, REF8-C
- Detector tester RE7T with hot air generator, RE8ST with smoke capsule RE8-S, RE8ST-CO with smoke capsule RE8-S, capsule RE8-CO, and CO capsule
- Detector tester RE10 for undertaking a function check on linear smoke detectors
- Telescope rods FDUM291/292 for extending detector exchanger, detector exchanger and tester, and other testers

## Properties

- 4-line display with 20 characters per line
- Menu-guided operation
- Supply with battery or via network adapter
- Possible to update the device software (firmware) via the MCL-USB adapter (radio) FDUZ227 and via a PC
- Environmentally friendly processing
- Reusable materials
- Electronic parts and synthetic materials can be easily separated

## Function

Different functions can be called up, e.g.:

- Number of devices found at A and B connection
- Line errors found, location of the line error
- Short-circuit, open line, ground fault with indication of which conductor/s
- Total resistance is too high and/or charge voltage at the line end is too low
- Data transmission fault due to line capacitance being too high
- Browsing from detector to detector with screen displaying type and serial number
- Display of branches and choice of branch for scrolling
- Activating the internal alarm indicator of the selected detector and recognizing the connected alarm sounder
- Extended operation and functionality on PC with line tester software FXS2017
- The line tester software FXS2017 is included in the scope of delivery of the line tester FDUL221.

Nr	Topology	Type	ID	Errors	Customer Text
1	A	FDM221	4001380	(+)->EARTH; Diode (+)	read using FDUL221
2	A	FDS221-R/-W	41205A0		
3	A	FDO221	429E8E7		
4	A	FDO221	42A4898		
5	A	FDS221-R/-W	4120602		
6	A	FDO221	429E768		
7	A	FDSB291			
7	A	FDO221	42A436D		
7	A	FDSB291			
8	A	FDO221	42A43A5		
8	A	FDSB291			
9	A	FDOOT221	402D94E		
9	A	T-Branch 2			
10	A	FDO221	42A46D0		
11	A	FDO221	42A436E		
12	A	FDOOT241-A4	48FA5CC		
13	A	FDO221	429E8E8		
14	A	FDS221-R/-W	4120582		
15	A	FDOOT221	402DA41		
16	A	FDS221-R/-W	4120595		
17	A	FDO221	42A4385		

Summary Panel:

Out A Out B Out C Out D

Date 2012-11-22T17:44:21.702000

Number of devices (total) 17

Branches 2

Devices in branches 5

Devices on Loop 12

Line type Loop

Line current 20.2mA\*

Leak current 4.2mA\*

Loop Resistance (+) 1.1Ω

Loop Resistance (-) 18.5Ω!

Loop Resistance (+), reverse 0.8Ω

Loop Resistance (-), reverse 47.8Ω!

Errors

- E07: Earth fault to plus wire
- E14: Diode in plus wire

Edit Customer Text:

read using FDUL221

Start Scan

Opened "xx\_small\_loop\_with\_errors" Offline

Line tester software FXS2017

The line tester FDUL221 is a universal device for the final testing of fully installed FDnet fire detector lines if a control panel is not connected. The device is used to search for errors for the electrician, installer, or service technician.

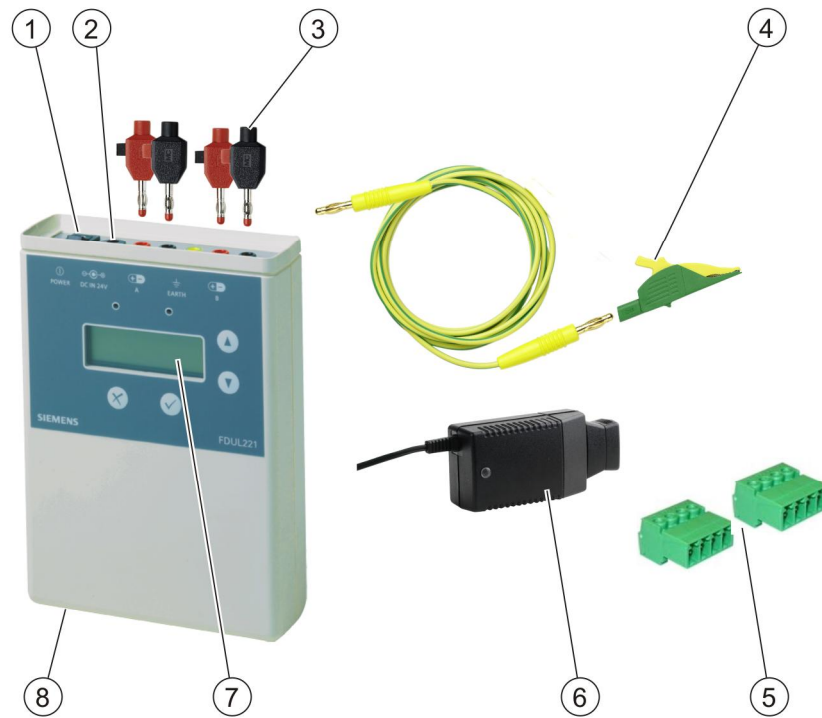

1 On/Off button

2 USB connection

3 Connection of a loop or stub line

4 Shielding

5 2x terminal strips for the detector line

6 Network adapter

7 Display

8 Battery compartment on the underside for 2x 9 V lithium batteries



Scope of delivery for FDUL221

## Detector exchanger FDUD291

### Properties

- Possible to exchange the detector without a ladder or scaffolding up to a room height of 8 m with the help of the telescope rods
- Joint springs enable the point detectors to be inserted or removed at an angle
- The point detector can be held in four rotational positions This makes it easier to work efficiently
- Specially developed springs hold the point detector in the detector exchanger
- Compatible with
  - Telescope rods FDUM291/292
  - Previous straight connectors VR10/11/12/13
  - MP/MT handles and straight connectors
- Environmentally friendly processing
- Reusable materials

### Function

- Efficient installation and removal of the point detectors FDO, FDOOT, FDT, FDOOTC

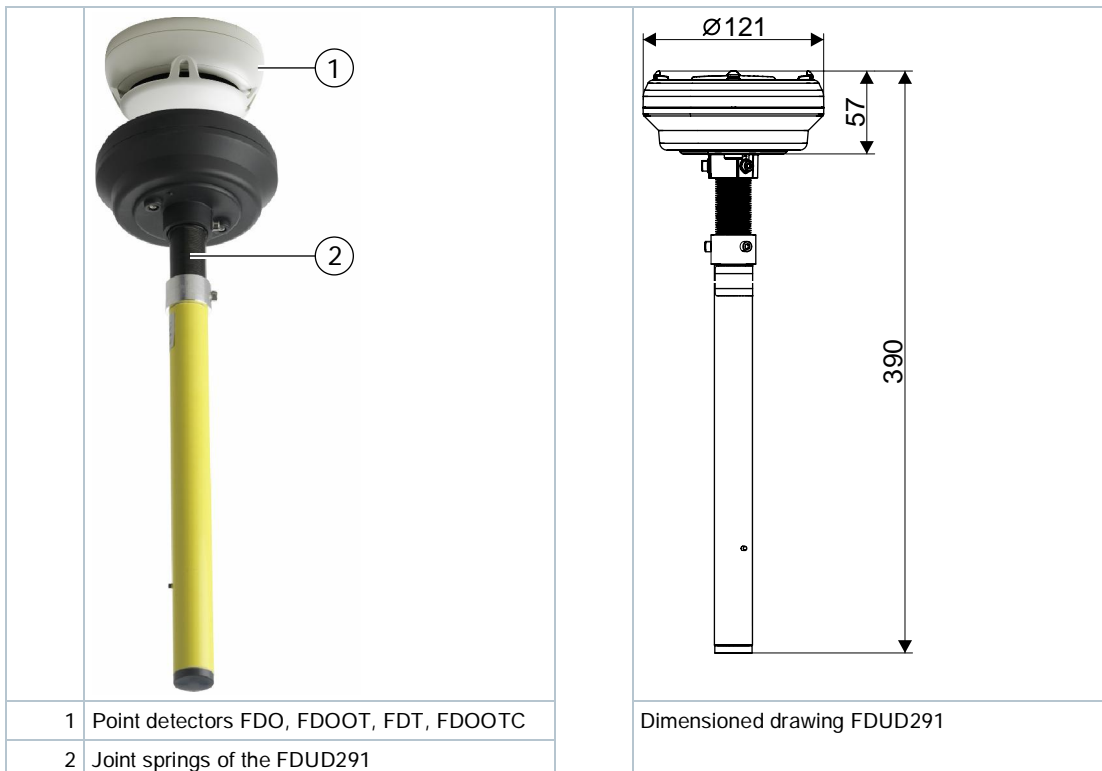

## Detector exchanger and tester FDUD292 and intelligent detector tester FDUD293

The detector exchanger and tester FDUD292 and the intelligent detector tester FDUD293 are universal tools for inserting and removing point detectors. The FDUD292 is used for commissioning and maintenance, and the FDUD293 for maintenance of the FNet devices. The following devices are exceptions:

- Flame detector FDF2x1-9
- Line separators FDCL221 and FDCL221-M
- Radio gateway FDCW221
- Radio manual call point FDM273
- Neural radio fire detector FDOOT271

## Properties

---

- Efficient and environmentally-friendly checking of the detectors without gas
- Possible to exchange the detector without a ladder or scaffolding up to a room height of 8 m with the help of the telescope rods
- Flexible springs allow the point detectors to be inserted and removed at an angle
- The point detector can be held in four rotational positions This makes it easier to work efficiently
- Specially developed springs hold the point detector in the detector exchanger and tester
- Efficient operation thanks to alphanumeric display with backlight and keyboard
- Clearly visible LED indicators for 'Test OK', 'Detector exchange recommended', 'Detector exchange obligatory'
- 9 V battery operation
- Compatible with
  - Telescope rods FDUM291/292
  - Previous straight connectors VR10/11/12/13
  - MP/MT handles and straight connectors
- Possible to update the device software (firmware) via the MCL-USB adapter (radio) and via a PC
- Environmentally friendly processing
- Reusable materials
- Electronic parts and synthetic materials can be easily separated

## Function FDUD292

---

- Efficient installation and removal of the point detectors FDO, FDOOT, FDT, FDOOTC
- Commissioning, maintenance, status checking, and testing of detectors with further diagnosis information directly on site
- Requesting parameters such as the bus address and changing detector settings
- Efficient error search on the detector and the control panel, particularly during installation
- Access levels with different functional scope
- Efficient testing through communication with the 'Sinteso Test' smartphone app; only with optional Bluetooth extension kit FDUD29x-E

## Function FDUD293

---

- Efficient installation and removal of the point detectors FDO, FDOOT, FDT, FDOOTC
- Testing and triggering detectors
- Efficient error search on the detector and the control panel, particularly during installation

## Use

---

The test device and line device communicate either wirelessly or via the MC link (Maintenance and Commissioning Link) with an adapter cable.

A wireless link is possible with the following line devices:

Device	Exceptions
All point detectors from the 'Sinteso™' product line: FDO, FDOOT, FDT, FDOOTC	FDOOT271
All manual call points FDM	FDM231, FDM233, FDM234, FDM234H, FDM273
All alarm sounders FDS	—

A link via the adapter cable FDUD292-A is possible with the following line devices:

Device	Exceptions
All modules FDCI and FDCIO	FDCI221, FDCI223, FDCIO221
Linear smoke detector FDL	—
Radio gateway FDCW221	—

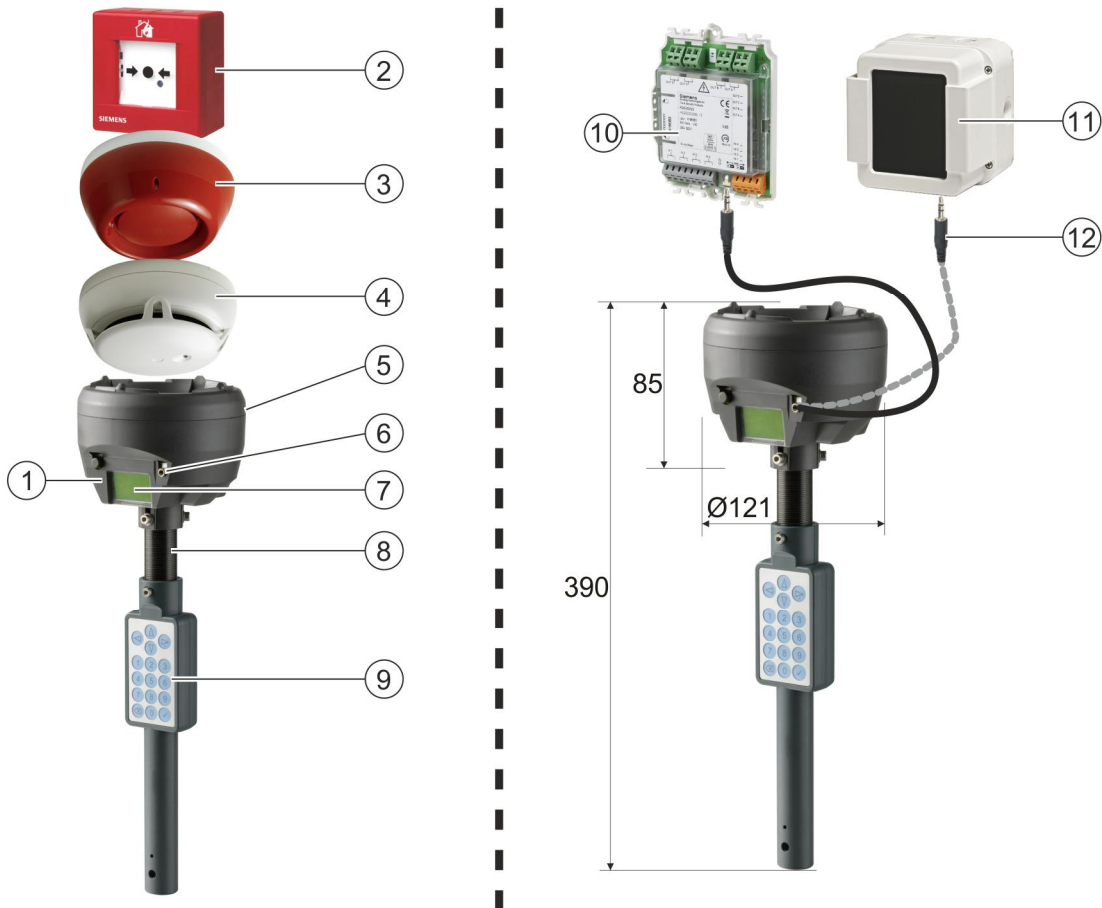

- 1 LEDs
- 2 Manual call point FDM
- 3 Alarm sounder FDS
- 4 Point detectors FDO, FDOOT, FDOOTC, FDT
- 5 Battery compartment on the rear
- 6 Adapter cable connection FDUD292-A
- 7 Display
- 8 Joint springs
- 9 Keypad
- 10 Modules FDC
- 11 Linear smoke detector FDL
- 12 Adapter cable FDUD292-A
- 13 Radio gateway FDCW221

## Bluetooth extension kit FDUD29x-E

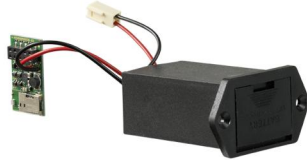

- For connecting the detector exchanger and tester FDUD292 to a mobile terminal
- Enables wireless data exchange between a detector exchanger and tester and a mobile terminal
- Compatible with detector exchanger and tester FDUD292

## 'Sinteso Test' Android app

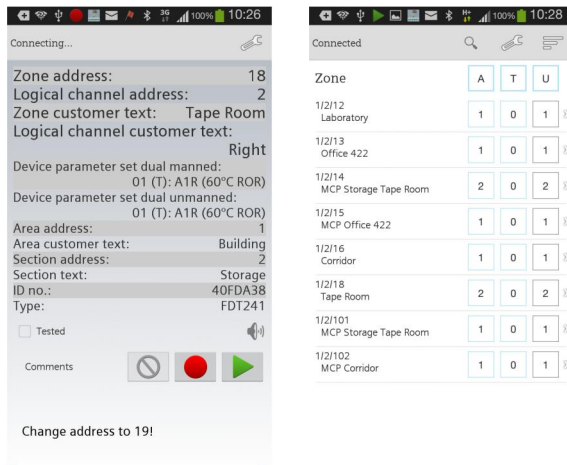

'Sinteso Test' simplifies the process of comparing the data stored in the detection tree with the device information for installed peripheral devices. 'Sinteso Test' is installed on a mobile terminal – for example, a smartphone – and used alongside a detector exchanger and tester FDUD292 and a Bluetooth extension kit FDUD29x-E.

The detector exchanger and tester FDUD292 with Bluetooth extension kit FDUD29x-E installed sends the 'serial no.', or 'ID no.', of an installed peripheral device to 'Sinteso Test'. 'Sinteso Test' displays the data assigned to the 'serial no.', or 'ID no.', in the detection tree. The detector exchanger and tester allows you to query the device information for the installed peripheral device and compare this with data from the detection tree.





- The detector tester RE6 is used together with a test gas can REF8, REF8-S, or REF8-C. It is designed to test optical smoke detectors, ionization detectors, and CO detectors.
- The detector tester is positioned over the detector for the testing process. Brief pressure causes the test gas to flow into the measuring chamber of the detector and therefore simulate the presence of fire aerosols. After a short period of time, the detector responds and triggers the alarm.
- REF8 and REF8-S are environmentally-friendly test gases and comply with strict environmental regulations. They do, however, contain flammable substances. REF8 is used for the temperature range 0...+40 °C and REF8-S for -20...+40 °C in dry and damp conditions. REF8-S is mainly used for temperatures below 0 °C or for point detectors that only trigger the alarm when there is a high level of smoke density or after longer signal integration.
- REF8-C is used to test the CO functionality of detectors with a CO sensor. REF8-C can be used in dry and damp conditions at temperatures between -20 °C and +50 °C.



When transporting, e.g., in a car, we recommend protecting the detector tester and the test gas cans from heat.

Please observe the notices on the detector tester for operation.





The heat detector tester kit consists of

- 1x heat detector tester
- 2x rechargeable batteries
- 1x charger with 12 V connection cable
- 2x mains cables AC 110/120-220/240 V.

The heat detector tester contains a hot air generator. The heat detector tester is positioned over the detector for the function check. The hot air emitted heats the detector which triggers this alarm.

In high rooms, detectors positioned at an angle can be reached and tested using adapters and telescope rods.

The adapter RE7T-A and telescope rods FDUM291/292 must be ordered separately.



The heat detector tester must not be used in electrical switching stations or areas where there is a danger of explosion.

---



The test kit RE8ST consists of

- 1x Testifire 1001-101 tester
- 1x RE8-S smoke capsule
- 2x rechargeable batteries
- 1x charger with 12 V connection cable
- 2x mains cables AC 110/120-220/240 V
- 1x USB cable.

The detector tester contains a smoke capsule. The detector tester is positioned over the detector for the function check. The smoke that is emitted triggers an alarm.

In high rooms, detectors positioned at an angle can be reached and tested using adapters and telescope rods.

The adapter RE7T-A and telescope rods FDUM291/292 must be ordered separately.



---

The detector tester must not be used in electrical switching stations or areas where there is a danger of explosion.

---



The test kit RE8STCO consists of

- 1x Testifire 2001-101 tester
- 1x RE8-S smoke capsule
- 1x RE8-CO CO capsule
- 2x rechargeable batteries
- 1x charger with 12 V connection cable
- 2x mains cables AC 110/120-220/240 V
- 1x USB cable.

The detector tester contains a smoke capsule or CO capsule. The detector tester is positioned over the detector for the function check. The smoke or gas that is emitted triggers an alarm.

In high rooms, detectors positioned at an angle can be reached and tested using adapters and telescope rods.

The adapter RE7T-A and telescope rods FDUM291/292 must be ordered separately.



---

The detector tester must not be used in electrical switching stations or areas where there is a danger of explosion.

---

**RE7T-A – Solo719 adapter for FDUM29x**



Mounting adapter for the detector testers RE7T, RE8ST, and RE8STCO on the telescope rods FDUM291 and FDUM292

**RE7T-B – Solo760 battery**



Battery as spare part

**RE7T-C – Solo725 charger**



Charger as spare part for charging the batteries RE7T-B

**RE8-S smoke capsule for RE8ST and RE8STCO**





**RE8-CO CO capsule for RE8STCO**



**Properties**

- Light and robust yellow plastic pipes – non-conductive material.
- Plastic sockets and friction bearings ensure that the pipes run into each other easily.
- Quick spring-type locking mechanisms allow continuous adjustment of the length.
- The pipes can be extended to their maximum length. A stop is used to prevent them from extending further.
- Previous testers can be used.
- The telescope rods cannot be extended.

	<p><b>⚠ WARNING</b></p>
	<p><b>Falling objects</b>                  Danger of injury</p> <ul style="list-style-type: none"> <li>• Always wear a hardhat when working with telescope rods.</li> </ul>

	<p><b>⚠ WARNING</b></p>
	<p><b>Approaching or touching live lines</b>                  Electric shock</p> <ul style="list-style-type: none"> <li>• Only use testers with telescope rods in volt-free areas.</li> </ul>

## FDUM291

- Light telescope rod for all applications in rooms up to 5.5 m high
- Flap closure for continuous adjustment of the length
- Three-part telescope with tri-oval pipes as practical grip
- Twisting the pipe in the opposite direction is not possible
- Weight: 1.2 kg without tester fitted
- Retracted length 1.6 m, extended length 4.2 m

## FDUM292

- Long and robust telescope rod for all applications in rooms up to 8 m high
- Flip top closure for continuous adjustment of the length
- Sturdy four-sided telescope with round pipes
- Weight: 3.4 kg without tester fitted
- Retracted length 2.1 m, extended length 7.3 m

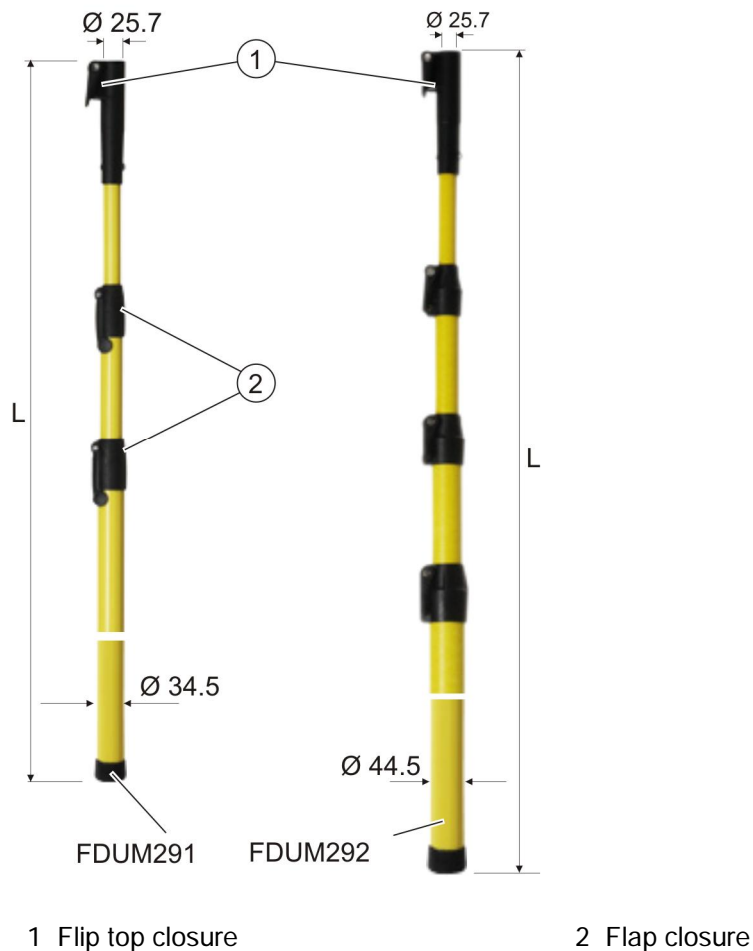

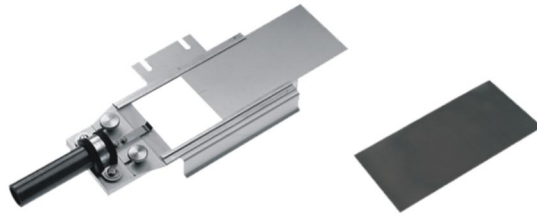

- For undertaking a function check on the linear smoke detectors. The alarm test filter TF04 is inserted into the detector tester in accordance with the type of detector to be tested.  
An alarm test filter is also included in the adjustment kit FDLU291.
- For testing, the detector tester is held in front of the detector lens in the IR beam. The detector responds after a few seconds.



The adjustment kit is used for commissioning the linear smoke detector FDL241-9. The lens of the linear smoke detector can be efficiently aligned to the reflector by one man.

**Scope of delivery:**

- Case with adjustment device
- Alarm test filter
- Visor
- Magnet
- Spiral cable
- MC link cable
- 9 V battery
- Suspension fixture with cable grippers and chain



## LE3 Test lamp



The test lamp LE3 is used to test the function of all flame detectors over distances up to 10 m. It is housed in a transportable case together with the required accessories. In addition, the case enables the test lamp to be kept in a dust-free condition.

The quartz-halogen lamp used creates an intense ray of light. This helps to align the lamp on the detector which is to be tested. During the detector test, the ray of light is modulated. The luminous intensity can be set in accordance with the distance.

The power is supplied by a rechargeable battery. Since the color of the light depends on the charge state of the battery, it must always be charged in buffer mode. A special charger is available for this.



### **▲ WARNING**

#### **Use of test lamps in areas at risk of explosion**

Risk of explosion

- Do not use the test lamp LE3 in areas at risk of explosion.

## Test lamp Stabex HF



The test lamp Stabex HF is used to test the function of intrinsically safe flame detectors in zone 1 or 2 areas at risk of explosion.

The lamp is used directly in front of the detector for the test. The ray of light must be pulsed with the sliding switch at half-second intervals.



### **▲ WARNING**

#### **Opening test lamps in areas at risk of explosion**

Risk of explosion

- Do not open the test lamp Stabex HF in areas at risk of explosion.

## Technical data

### Line tester FDUL221

Supply voltage	Min. DC 10 V, max. DC 30 V
Battery or via	2 x 9 V
Network adapter	AC 240 V / DC 24 V, 625 mA
Power consumption during measurement	Depends on the number of devices and the display backlight
Detector line voltage: FDnet – FS20, AlgoRex	DC 32 V
FDnet – SIGMASYS	DC 28 V
Max. detector key figures (MK) per line	
MK with network adapter	Min. 550
MK with battery	Min. 150
Operating temperature	-25...+40 °C
Storage temperature without battery	-30...+75 °C
Storage temperature with battery	-25...+60 °C
Air humidity (no condensation permitted)	≤95 % rel.

### Detector exchanger and tester FDUD292, intelligent detector tester FDUD293

Supply voltage	DC 9 V
Alkali battery	Standard 9 V battery
Lithium manganese dioxide battery for temperatures below -10 °C	ULTRALIFE U9VL or U9VL-J Capacity 950 – 1200 mAh
Operating current:	
Ready – light on/off	2 mA / 42 mA
Communication – 3 LEDs + buzzer	95 mA
Operating temperature	-20...+40 °C
Storage temperature	-30...+75 °C
Storage temperature with battery	-25...+60 °C
Air humidity (no condensation permitted)	≤95 % rel.

### Detector tester RE6

Operating temperature	
REF8	0...+40 °C
REF8-S	-20...+40 °C
REF8-C	-20...+50 °C
Storage temperature	-20...+40 °C
Number of detector tests; dependent on detector type	Max. 400

### Heat detector tester RE7T

Operating temperature	5...+45 °C
Storage temperature	-10...+50 °C
Air humidity (no condensation permitted)	≤95 % rel.
Voltage	Auto: DC 12 V Mains: AC 110/120-220/240 V
Charging time	Approx. 1 hour per battery

### Detector tester RE8ST/RE8STCO







Operating temperature	5...+45 °C
Storage temperature	-10...+50 °C

<b>Detector tester RE8ST/RE8STCO</b>	
Air humidity (no condensation permitted)	≤95 % rel.
Voltage	Auto: DC 12 V Mains: AC 110/120-220/240 V
Charging time	Approx. 1 hour per battery

<b>Adjustment kit FDLU291</b>	
Dimensions of the adjustment device	120 x 65 x 22 mm

<b>Test lamp LE3</b>	
Power consumption	50 W
Modulation frequency	4 Hz
Max. distance for alarm activation	10 m
Measuring capacity with charged battery and max. distance Number of detectors	~ 50
Operating and storage temperature	-20...+45 °C
Areas of use	Areas not at risk of explosion
Incandescent lamp	Halogen 12 V / 50 W
Battery	12 V / 7 Ah, lead, gas tight
Charging time	Min. 16 h
Mains connection charger	AC 220 / 240 V, 50...60 Hz
Dimensions	
<ul style="list-style-type: none"> <li>• Test lamp</li> <li>• Battery</li> </ul>	178 x 180 x 369 mm 153 x 103 x 67 mm

<b>Test lamp Stabex HF</b>	
Max. distance for alarm activation	A few cm
Operating and storage temperature	-20...+40 °C
Explosion protection	II 2 G EEx ib e IIC T4
Ex approval	PTB 98 ATEX 2062
Areas of use	Zones 1 and 2
Protection category	IP65
Incandescent lamp	Halogen 2.8 V / 0.5 A
Battery	2x alkali batteries 1.5 V Mono cell UM-1

	<b>FDUL221</b>	Siemens Switzerland Ltd, Gubelstrasse 22 CH-6301 Zug Technical data: see doc. <b>008250</b>
	FDUL221 - Line tester Sinteso. Test equipment for use in fire detection and fire alarm systems installed in buildings.	
	2014/30/EU (EMC): EN 50130-4 / EN 61000-6-3 ; 2011/65/EU (RoHS): EN 50581 / EN 55024	
	The declared conformity can be seen in the EU Declaration of Conformity (DoC), which is obtainable via the Customer Support Center: Tel. +49 89 9221-8000 or <a href="http://siemens.com/bt/download">http://siemens.com/bt/download</a>	
	DoC: No.: CED-FDUL221	
	<b>FDUD292</b>	Siemens Switzerland Ltd, Gubelstrasse 22 CH-6301 Zug Technical data: see doc. <b>007227</b>
	FDUD292 - Detector tester. Test equipment for use in fire detection and fire alarm systems installed in buildings.	
	2014/53/EU (RED): EN 300 220-2 / EN 301 489-3 / EN 60950-1 ; 2011/65/EU (RoHS): EN 50581	
	The declared conformity can be seen in the EU Declaration of Conformity (DoC), which is obtainable via the Customer Support Center: Tel. +49 89 9221-8000 or <a href="http://siemens.com/bt/download">http://siemens.com/bt/download</a>	
	DoC: No.: CED-FDUD292-293	
	<b>FDUD293</b>	Siemens Switzerland Ltd, Gubelstrasse 22 CH-6301 Zug Technical data: see doc. <b>009718</b>
	FDUD293 - Detector tester. Test equipment for use in fire detection and fire alarm systems installed in buildings.	
	2014/53/EU (RED): EN 300 220-2 / EN 301 489-3 / EN 60950-1 ; 2011/65/EU (RoHS): EN 50581	
	The declared conformity can be seen in the EU Declaration of Conformity (DoC), which is obtainable via the Customer Support Center: Tel. +49 89 9221-8000 or <a href="http://siemens.com/bt/download">http://siemens.com/bt/download</a>	
	DoC: No.: CED-FDUD292-293	
	<b>FDUZ227</b>	Siemens Switzerland Ltd, Gubelstrasse 22 CH-6301 Zug Technical data: see doc. <b>A6V10355605</b>
	FDUZ227 - Radio modem. Test equipment for use in fire detection and fire alarm systems installed in buildings.	
	2014/53/EU (RED): EN 300 220-2 / EN 301 489-1 / EN 301 489-3 / EN 62479 ; 2011/65/EU (RoHS): EN 50581	
	The declared conformity can be seen in the EU Declaration of Conformity (DoC), which is obtainable via the Customer Support center: Tel. +49 89 9221-8000 or <a href="http://siemens.com/bt/download">http://siemens.com/bt/download</a>	
	DoC No.: CED-FDUZ227	
	<b>LE3</b>	Siemens Switzerland Ltd, Gubelstrasse 22 CH-6301 Zug Technical data: see doc. <b>000252</b>
	LE3 - Test lamp. Test equipment for use in fire detection and fire alarm systems installed in buildings.	
	2014/30/EU (EMC): EN 50130-4 / EN 61000-6-3 / EN 61010-1 / EN 55024 ; 2011/65/EU (RoHS): EN 50581	
	The declared conformity can be seen in the EU Declaration of Conformity (DoC), which is obtainable via the Customer Support Center: Tel. +49 89 9221-8000 or <a href="http://siemens.com/bt/download">http://siemens.com/bt/download</a>	
	DoC: No.: CED-LE3	
	<b>STABEX HF</b>	Siemens Switzerland Ltd, Gubelstrasse 22 CH-6301 Zug Technical data: see doc. <b>A6V10248358</b>
	STABEX HF - Stabex HF Hand lamp. Test equipment for use in fire detection and fire alarm systems installed in buildings.	
	2014/34/EU (ATEX): EN 60079-0 / EN 60079-7 / EN 60079-11 / EN 60079-31 ; 2011/65/EU (RoHS): EN 50581	
	The declared conformity can be seen in the EU Declaration of Conformity (DoC), which is obtainable via the Customer Support Center: Tel. +49 89 9221-8000 or <a href="http://siemens.com/bt/download">http://siemens.com/bt/download</a>	
	DoC: No.: CED-STABEX_HF	

## Details for ordering

	Type	Item number	Designation	Weight
Line tester	FDUL221	A5Q00004397	Line tester with line connection kit FDUL221-A, power unit set FDUL221-B and carry case	1.567 kg
Accessories	-	A5Q00004142	Lithium manganese dioxide battery 9 V / 1.2 Ah	0.035 kg
Spare part	FDUL221-A	A5Q00008436	Line connection set	0.088 kg
	FDUL221-B	A5Q00008437	Power unit set	0.292 kg
	FDUL221-C	A5Q00008438	PC cable RS232 as spare part for FDUL221 with interface RS232	0.037 kg

	Type	Item number	Designation	Weight
Detector exchanger	FDUD291	A5Q00003585	Detector exchanger	0.594 kg
Detector exchanger and tester	FDUD292	A5Q00003357	Detector exchanger and tester incl. adapter cable FDUD292-A	1.079 kg
Intelligent detector tester	FDUD293	A5Q00018261	Intelligent detector tester incl. adapter cable FDUD292-A	1.079 kg
Accessories	-	A5Q00004142	Lithium manganese dioxide battery 9 V / 1.2 Ah	0.035 kg
Spare part	FDUD292-A	A5Q00004990	Adapter cable, audio stereo cable with 3.5 mm jack plug	0.040 kg

	Type	Item number	Designation	Weight
Bluetooth extension kit	FDUD29x-E	S54319-Z30-A1	Bluetooth extension kit	0.028 kg

	Type	Item number	Designation	Weight
Detector tester	RE6	BPZ:3680300001	Detector tester for smoke detectors	0.950 kg
Accessories	REF8	A5Q00011687	Test gas can	0.194 kg
	REF8-S	A5Q00011688	Test gas can	0.186 kg
	REF8-C	S54370-N2-A1	Test gas can CO	0.203 kg

	Type	Item number	Designation	Weight
Detector tester	RE7T	S54370-S3-A1	Solo461 heat detector tester kit consisting of tester, 2 batteries, charger, cable	2.800 kg
Accessories	RE7T-A	S54370-N4-A1	Solo719 adapter for FDUM29x	0.260 kg
Spare part	RE7T-B	S54370-N5-A1	Solo760 battery for RE7T	1.090 kg
	RE7T-C	S54370-N6-A1	Solo725 charger for RE7T	1.210 kg

	Type	Item number	Designation	Weight
Detector tester	RE8ST	S54370-S23-A1	Testifire 1001-101 ST test kit	3.470 kg
	RE8STCO	S54370-S24-A1	Testifire 2001-101 STCO test kit	3.750 kg
Capsule	RE8-S	S54370-N25-A1	TS3 smoke capsules (6 pieces)	0.079 kg
	RE8-CO	S54370-N22-A1	TS3 CO capsules (6 pieces)	0.077 kg
Accessories	RE7T-A	S54312-F3-A1	Solo719 adapter for FDUM29x	0.260 kg
Spare part	RE7T-B	S54370-N5-A1	Solo760 battery for RE7T <sup>1</sup>	1.090 kg
	RE7T-C	S54370-N6-A1	Solo726 charger for RE7T <sup>1</sup>	1.210 kg

<sup>1)</sup> Compatible with RE8ST and RE8STCO

	Type	Item number	Designation	Weight
Telescope rod	FDUM291	A5Q00004996	Telescope rod – three-part telescope with tri-oval pipes; 1.6 m / 4.2 m	1.960 kg
Spare part	–	A5Q00009787	Lever with screw and nut – flip top closure	0.023 kg
	–	A5Q00009786	Adapter with lever, screw, and nut incl. mounting and sleeve bolt	0.088 kg
	–	A5Q00009788	Small flap with screw and nut – flap closure	0.015 kg
	–	A5Q00009789	Large flap with screw and nut – flap closure	0.016 kg

	Type	Item number	Designation	Weight
Telescope rod	FDUM292	A5Q00004997	Telescope rod – four-part telescope with round pipes; 2.1 m / 7.3 m	4.480 kg
Spare part	–	A5Q00009787	Lever with screw and nut – flip top closure	0.023 kg
	–	A5Q00009786	Adapter with lever, screw, and nut incl. mounting and sleeve bolt	0.088 kg

	Type	Item number	Designation	Weight
Detector tester	RE10	BPZ:3685190001	Detector tester for linear smoke detectors	0.345 kg
Alarm test filter for RE10	TF04	BPZ:4931090001	Alarm test filter – absorption 77 %	0.005 kg

	Type	Item number	Designation	Weight
Adjustment kit	FDLU291	A5Q00004905	Adjustment kit for linear smoke detector incl. case	0.840 kg

	Type	Item number	Designation	Weight
Test lamp	LE3	BPZ:3669510001	Test lamp for flame detector incl. case and charger, without battery	5.260 kg
Accessories	FA2003-A1	A5Q00019353	Battery 12 V / 7 Ah / VdS	2.293 kg
Spare part		BPZ:3679630001	Halogen lamp 12 V / 50 W	0.395 kg

	Type	Item number	Designation	Weight
Test lamp	Stabex HF	BPZ:4620910001	Test lamp for areas at risk of explosion	0.175 kg

## Applicable documents

Document ID	Name
008331	List of compatibility (for 'Sinteso™' product line)
008164	Equipment overview Sinteso™ Detector system FD20
007227	Technical manual Detector exchanger and tester FDUD292
009718	Technical Manual Intelligent detector tester FDUD293
A6V10254740	Operating instructions Solo461 heat detector tester kit RE7T
A6V10387053	Installation RE8ST Testfire 1001-101 ST test kit, RE8STCO Testfire 2001-101 STCO test kit
A6V10260320	Operation RE7T-C Solo726 charger for RE7T-B
008250	Technical Manual Line tester FDUL221
A6V10395483	Line tester – operating instructions for electricians
A6V10424692	Installation, Commissioning Sinteso Test
A6V10405496	Installation Bluetooth extension kit FDUD29x-E
007016	Technical manual Linear smoke detector FDL241-9
000257	Operating instructions Test lamp LE3
<b>Safety data sheets</b>	
A5Q00011687D	Safety data sheet REF8
A5Q00011688D	Safety data sheet REF8-S
A5Q00035329C	Safety data sheet REF8-C

MCL-USB adapter (radio) FDUZ227, see data sheet A6V10355605.